



bre

**Weathertightness test to
BS 6375: Part 1: 2004 on
a Smart Systems Ltd
glazed screen**

Prepared for: Mr. S. Counsell

Smart Systems Ltd

21 October 2005

Test report number 225 066



0578

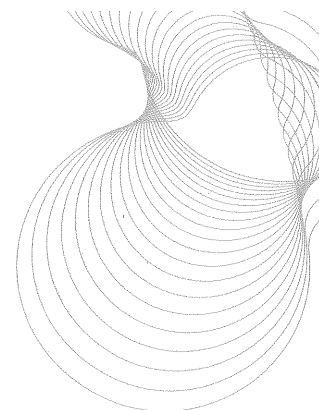

Tested by	
Name	Malcolm Pound
Position	Laboratory Manager
Date	03 October 2005
Signature	<i>M.C. Pound</i>

Prepared by

Name	Malcolm Pound
Position	Laboratory Manager
Date	21 October 2005
Signature	<i>M.C. Pound</i>

Approved on behalf of BRE

Name	Dr. P. Blackmore
Position	Associate Director of Actions, Centre for Materials and Engineering
Date	25.10.05
Signature	<i>pp Blackmore (COACHMAN)</i>

BRE
Garston
WD25 9XX
T + 44 (0) 1923 664000
F + 44 (0) 1923 664010
E enquiries@bre.co.uk
www.bre.co.uk

BRE is not UKAS accredited to make opinions and interpretation. Any opinions and interpretations included as part of this report are clearly marked as such.



0578

This report may only be distributed in its entirety and in accordance with the terms and conditions of the contract. Test results relate only to the items tested. BRE has no responsibility for the design, materials, workmanship or performance of the product or items tested. This report does not constitute an approval, certification or endorsement of the product tested.

This report is made on behalf of BRE. By receiving the report and action on it, the client – or any third party relying on it – accepts that no individual is personally liable in contract, tort or breach of statutory duty (including negligence).

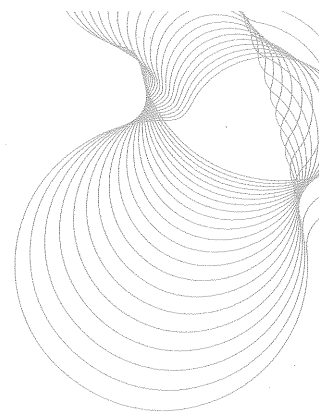

1 Introduction

At the request of Mr.S Counsell of Smart Systems Ltd, Arnolds Way, Yatton, North Somerset, BS49 4UN, BRE issued proposal number 225 066 on 23 August 2005. The proposal was accepted on 25 August and the specimen glazed screen tested by BRE on 03 October 2005.

The tests to methods in BS 6375: Part 1: 2004, BS EN 1026¹, 1027² and 12211³ measure the weathertightness of the specimen glazed screen in terms of air permeability, watertightness and resistance to wind load respectively. Classification of the results is based on BS 6375: Part 1: 2004⁴ and BS EN 12207⁵, 12208⁶, 12210⁷.

In this case the maximum test pressures requested by the client for the specimen are 600 Pa (Pascals) for air permeability, 600 Pa for watertightness and 2000 Pa as the test pressure P1 in the resistance to wind load test.

The tests on the specimen were carried out under the BRE Standard Terms and Conditions of Business and to the UKAS BRE Specific Procedures Series F, as BRE Job number 225 066 in project number CV0452.

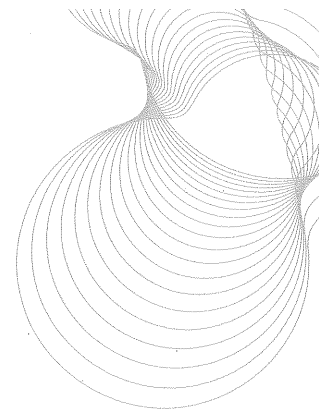

2 Details of tests carried out

The weathertightness test on the test specimen was carried out to the requirements of BS 6375: Part 1: 2004, BS EN's 1026, 1027 and 12211 for air permeability, watertightness and resistance to wind load.

BS 6375: Part 1: 2004 classifies the results for products in the UK and also specifies that the air permeability test is performed under both positive and negative test pressures. BS 6375: Part 1: 2004 and BS ENs 12207, 12208 and 12210 classify the weathertightness performance of completely assembled windows of any material after testing to the methods below. When a specimen has fixed lights only (as is the case with this glazed screen) classification of air permeability is based on the leakage values for the overall area of the specimen's interior face.

The weathertightness test comprised of three parts in the sequence:

1. Air permeability to BS EN 1026: 2000; by application of a series of test air pressure differentials across the specimen with measurement of the air permeability of it at each pressure step. The maximum positive and negative pressure differential was 600 Pa reached in pressure steps of 50, 100, 150, 200, 250, 300, 450 and 600 Pascals.
2. Watertightness to BS EN 1027: 2000; by applying specified amounts of water spray to the outside face of the specimen while incrementally increasing the air pressure differential across it. The test pressure, time and position of any water penetration are recorded. The maximum positive air pressure differential was 300Pa. Pressure (Pa)/time (min) steps were 0/15, 50/5, 100/5, 150/5, 200/5, 250/5 and 300/5.
3. Resistance to wind load to BS EN 12211: 2000; by application of a series of positive and negative test air pressures. Measurements and inspections are made to assess relative frontal deflection and resistance to damage from wind loads.

The resistance to wind load test includes a deflection test, a repeated pressure test and operational test, an air permeability test and finally a safety test. For the purpose of the resistance to wind load test three test pressures are defined:

- P1 applied to measure the deflections of parts of the test specimen.
- P2 50 cycles of pulsating pressure to assess performance under repeated wind loads.
- P3 applied to assess the safety of the test specimen under extreme conditions.

The values of P1, P2 and P3 are related as follows: $P2 = 0.5P1$, $P3 = 1.5P1$.
For these tests the values are: P1 = 2000 Pa, P2 = 1000 Pa and P3 = 3000 Pa.

Note: The repeat air permeability test is an integral part of the resistance to wind load test and its significance is as an indicator of damage that may occur during that test.

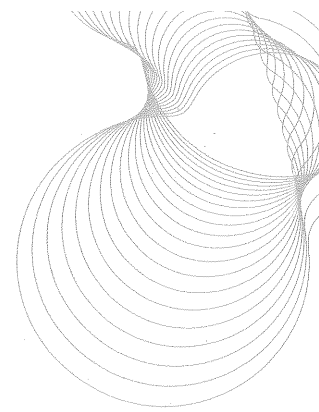

3 Classification of results

According to BS 6375: Part 1: 2004 for a specimen to be included in an exposure category the test pressures for air permeability, watertightness and resistance to wind shall be attained or exceeded. The classifications given in BS 6375 are those suitable for the UK selected from the forgoing standards. The specimen was tested to a UK exposure category of 2000 (Pa).

The classifications from BS 6375: Part 1: 2004 for a UK exposure category of 2000 has air permeability at Class 2/300 Pa, watertightness at Class 5A/200 Pa and resistance to wind load at Class 5, P1 2000 Pa, P2 1000 Pa and P3 3000 Pa.

The BS EN classifications are explained below:

- Air permeability** BS EN 12207: 1999. The classification is based on a comparison of the air permeability of the test specimen related to both overall area and length of opening joint. There are four classes; class 4 is applicable to the most airtight specimens while class 1 describes those with most air leakage. To meet any class the measured air permeability of the specimen must not exceed the upper limit at any test pressure step in that class.
- Watertightness** BS EN 12208: 2000. The classification is based on a comparison of the watertightness of the test specimen related to test pressures and duration of the test. There are nine classes; 1A/1B up to 9A for test pressures from 0 Pa to 600 Pa. For specimens that remain watertight over 600 Pa for 5 minutes a class Exxx is used. The xxx is the maximum test pressure e.g. 750 Pa. To meet any class the specimen must remain watertight for 5 minutes up to and at the test pressure set for that class.
- Resistance to wind load** BS EN 12210: 1999. The classification is based on a comparison of the resistance to wind loads of the test specimen when subjected to test pressures P1, P2 and P3. There are five classes; 1 up to 5 for P1 test pressures from 400 Pa to 2000 Pa. For specimens that are tested to P1 pressures exceeding 2000 Pa a class Exxxx is used. The xxx is the actual test pressure P1 used e.g. 2400 Pa. To achieve any class the resistance of the specimen to wind load must meet all the requirements for that class.
- Note:** Neither BS 6375: Part 1: 2004 or BS EN 12207: 1999 give guidance on how to classify the performance of windows when the air permeability under positive and negative pressures are significantly different. BRE's interpretation is that separate classifications are given for the performances under positive and negative test pressures respectively.

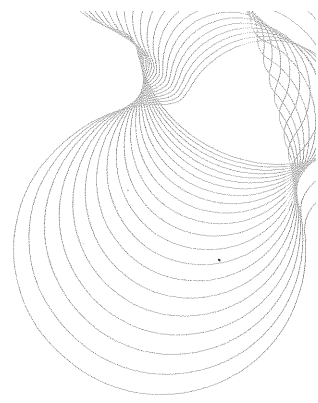

4 Test specimen

The general details about the test specimen supplied by Smart Systems Ltd for these tests are given below:

- Type:** Aluminium transom and mullion frame members with nine equal sized fixed lights. The screen has a top transom and a bottom sill member with two intermediate transoms spaced equally between. There are four (vertical) mullions; one at each side and two spaced equally between at right angles to the transoms. Reference: Smart Systems Ltd SC-Frame. Drawing reference: SC Test
- Glazing:** The frame is glazed from the outdoor face with nine insulating glass units with 6 mm thick toughened glass and a 12 mm air gap. Aluminium pressure plates with snap on covers retain the glazing seals and the glazing.
- Seals:** The frame carries a compression type seal. The glazing is pressed onto these by pressure plates that are fixed with screws to the outdoor face of the transoms and mullions. The pressure plates also house the outdoor glazing seals that bear onto the glass. Frame joints and corner joints of the seals have a sealant applied to them.
- Hardware:** Being all fixed lights there is no hardware.
- Fixings:** For these tests the specimen was fixed and sealed into a wood surround frame with screws.
- Detail:** There are two drain points at the cover plate below each fixed light and at the sill. The frame members are powder coated white.
- Dimensions:** 2.38 mm high x 2.88 mm wide (overall). Area: 6.85 m²

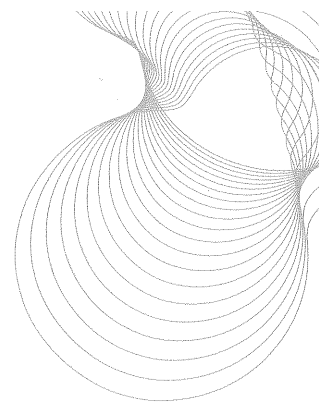

5 Test rig and preparatory procedures

The test specimen was conditioned for at least 4 hours within temperature and humidity ranges specified in the test standards of 10°C to 30°C and 25% to 75% RH respectively.

The water temperature in the watertightness test was within the specified range of 4°C to 30°C.

The specimen was mounted in the BRE test rig 'G', to form one wall of a pressure box, with the outdoor face of the specimen enclosed in the box.

A single spray bar with six full circular cone nozzles was mounted in the pressure box to apply water to the outside face of the specimen at the rate of 2 L/min per nozzle in accordance with BS EN 1027 spraying method 1A.

Transducers were mounted on independent supports to measure deflections of a frame member retaining an insulating glass units. Deflections were measured on the span at the positions indicated in Figure 1.

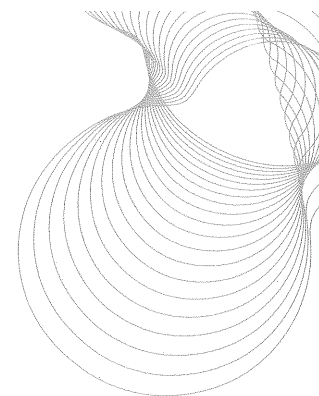

6 Summary of test results

The test results are summarised in Table 1 below. Figures show detail of the window and detailed results are given in Annex 1.

Tests	BS EN requirements		Test specimen performance	
	Max. test pressures Pa	Requirements	Test results	Classification
Air permeability	600	Max. air leakage rate at 600 Pa not to exceed: 10.00 m ³ /h.m ² in Cl.4 Negative pressures	At 600 Pa: 0.12 m ³ /h.m ² 0.24 m ³ /h.m ²	Class 4 Class 4
Watertightness	600	No leaks up to and at 600 Pa – Class 9A	No leakage	Class 9A
Resistance to ± wind load	P1 = 2000 P2 = 1000 P3 = 3000	At P1 and P2: Deflection of frame member not to exceed 1/150	max. 1/412 on an intermediate mullion at -2000 Pa	Classification of relative frontal deflection: Class C
		No visible failures. Remain functional.	No failures. Functions OK.	Classification of wind load: Class 5
		Increase in air perm' not greater than 20% of the max. permissible air perm' for the class attained in the 1 st air perm' test	Insignificant change under ± test pressures	
		At P3: No parts become detached and specimen remains closed	Intact and remained closed	Overall Classification for resistance to wind load: Class C5

Table 1. Summary of weathertightness test results

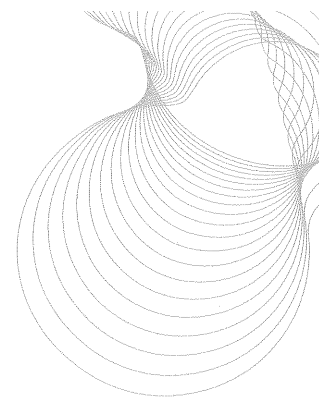

7 Conclusions

When the specimen Smart Systems Ltd glazed screen was tested to the standards described herein it was found to be:

- Sufficiently airtight to attain Class 4 in BS EN 12207: 2000 under positive and negative test pressures.
- Resistant to water penetration using method 1A to Class 9A at 600 Pa as in BS EN 12208: 2000.
- Resistant to wind loads of ± 2000 Pa causing deflections less than $1/300$ of the span of an intermediate mullion, resistant to repeated pressure cycles of ± 1000 Pa and able to sustain the corresponding safety test pressure of ± 3000 Pa. The overall classification for resistance to wind load is Class C5 as in BS EN 12210: 2000.
- According to BS 6375: Part 1: 2004 this specimen glazed screen as described herein would be suitable for UK exposure categories of 2000. When tested to a design wind load of 2000 (Pa) the performance of the specimen exceeded the classes prescribed in BS 6375. They are Class 2 for air permeability under positive and negative test pressures, Class 5A at 200 Pa for watertightness and Class 5 for resistance to wind when $P1 = \pm 2000$.

8 References

1. BS EN 1026: 2000. Windows and windows – Air permeability – Test method. British Standards Institution, London.
2. BS EN 1027: 2000. Windows and windows – Watertightness – Test method. British Standards Institution, London.
3. BS EN 12211: 2000. Windows and windows – Resistance to wind load – Test method. British Standards Institution, London.
4. BS 6375: Part 1: 2004. Performance of windows and windows – Classification for weathertightness and guidance on selection and specification
5. BS EN 12207: 2000. Windows and windows – Air permeability - Classification. British Standards Institution, London.
6. BS EN 12208: 2000. Windows and windows – Watertightness - Classification. British Standards Institution, London.
7. BS EN 12210: 2000. Windows and windows – Resistance to wind load - Classification. British Standards Institution, London.

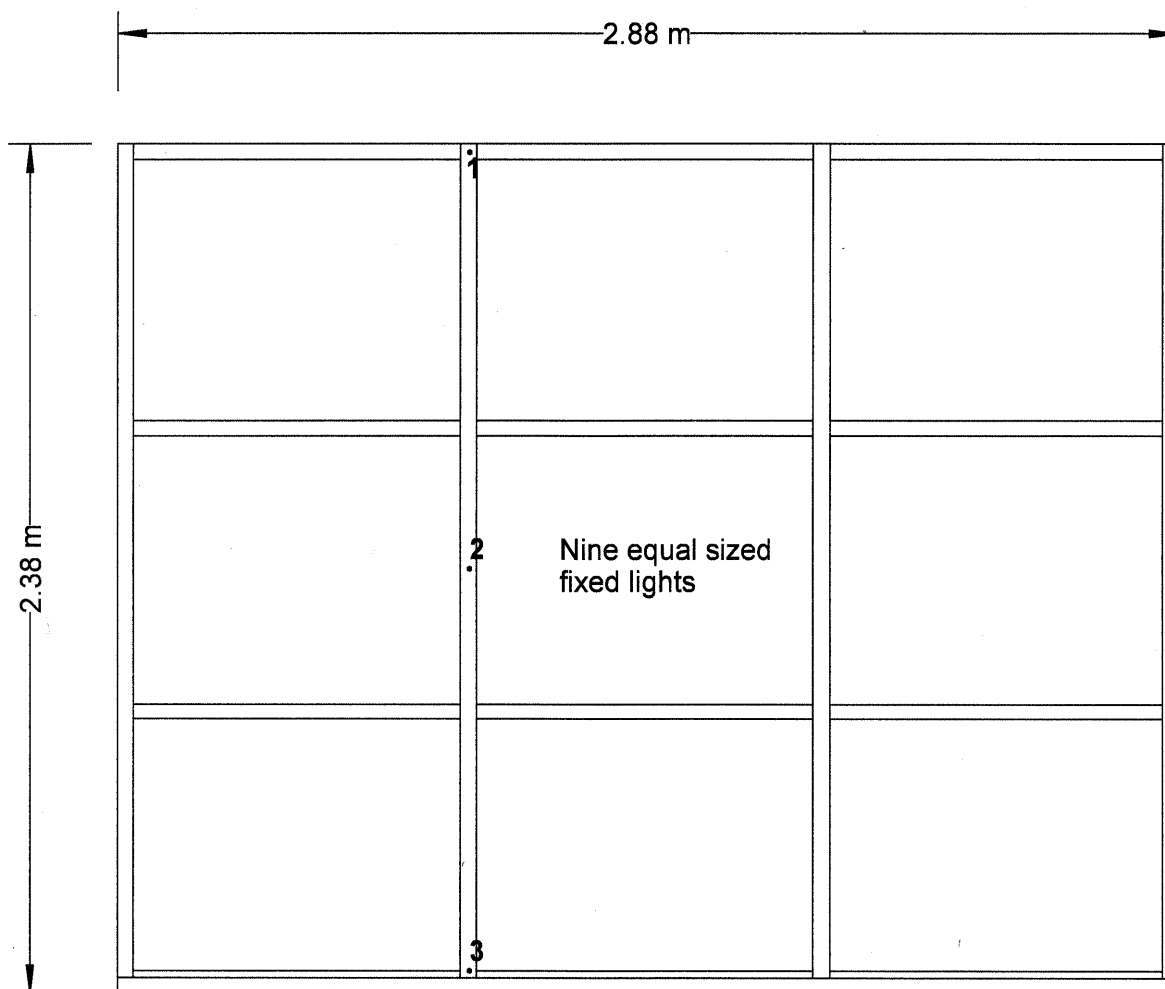
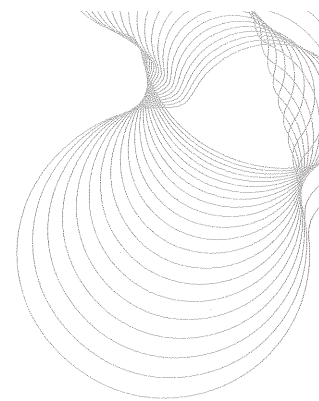

• = Points 1, 2 and 3 where deflections were measured

Figure 1. Outline sketch of the inside face of the glazed screen showing positions of deflection measurement points on a mullion

THIS DRAWING IS FOR INFORMATION PURPOSES ONLY AND DOES NOT IMPLY SMART SYSTEMS LTD APPROVAL OF THE PROPOSAL AS DRAWN.

TECHNICAL INFORMATION

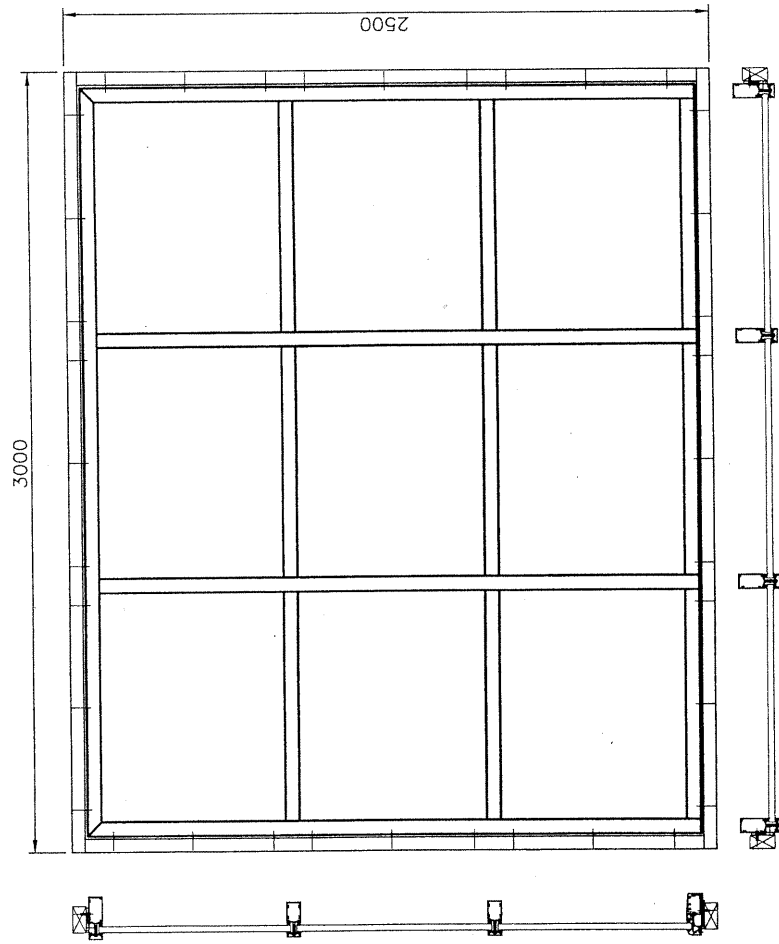
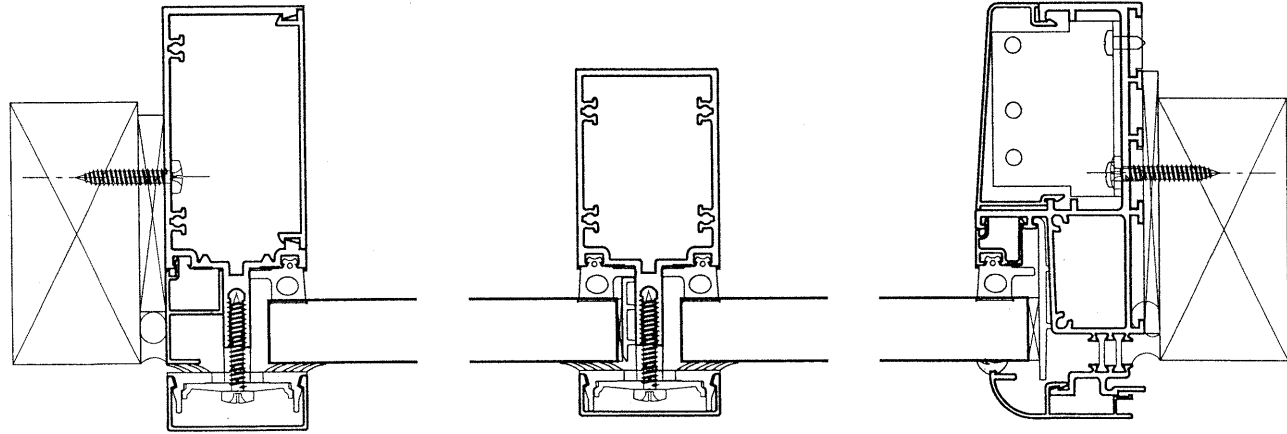

PROFILES

- Mullion - SC014 + SC050
- Top Transom - SC014 + SC050
- Intermediate Transom - SC031
- Sill - MC070 + MC076
- Pressure Plate - DK154
- Cover Caps
- Mullion & Top - DK053
- Intermediate Transom - DK052
- Sill - SC053
- Periphery Closer - SC063

ACCESSORIES

- Isolator - ACSC001
- Transom End Pad - ACSC002
- Transom End Block - ACSC003
- Transom Glass Shelf - ACSC009
- Jamb Bracket to MC070 - ACSC073
- Mullion Bracket to MC070 - ACSC074
- Back Gasket - ACSC212N
- Packer for DK154 - ACDK066
- Sill Glass Shelf - ACMC071
- DK154 Screw - ACMC109
- SC053 Wedge Gasket - ACVG33

GLASS

24mm Unit 6/12/6 Toughened

SMART SYSTEMS LTD, ARNOLDS WAY, YATTON, NORTH SOMERSET, BS49 4AW, TEL-(01934) 876100 NO UNAUTHORISED USE COPY OR DISCLOSURE OF THIS DRAWING IS TO BE MADE AND IT IS TO BE RETURNED WHENEVER REQUIRED. COPYRIGHT SMART SYSTEMS LTD.	DATE SEPT '05	TITLE SC-Frame - Weather Test	SCALE 1:2 1:20	DWG No. SC TEST
---	------------------	----------------------------------	-------------------	--------------------

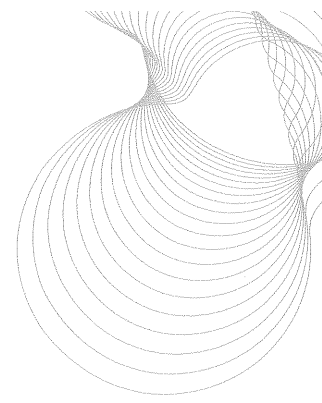

ANNEX 1. Weathertightness test results

Air permeability test under positive air pressure

Pressure differential Pa	Air flow through the specimen m ³ /h	Air flow per unit area of the specimen m ³ /h.m ²
50	0.28	0.04
100	0.13	0.02
150	0.14	0.02
200	0.37	0.05
250	0.61	0.09
300	0.60	0.09
450	1.09	0.16
600	0.85	0.12

Table A1. Air permeability under positive air pressure; test results

Air permeability test under negative air pressure

Pressure differential Pa	Air flow through the specimen m ³ /h	Air flow per unit area of the specimen m ³ /h.m ²
50	0.37	0.05
100	0.18	0.03
150	0.45	0.07
200	0.55	0.08
250	0.83	0.12
300	0.74	0.11
450	1.66	0.24
600	1.61	0.24

Table A2. Air permeability under negative air pressure; test results

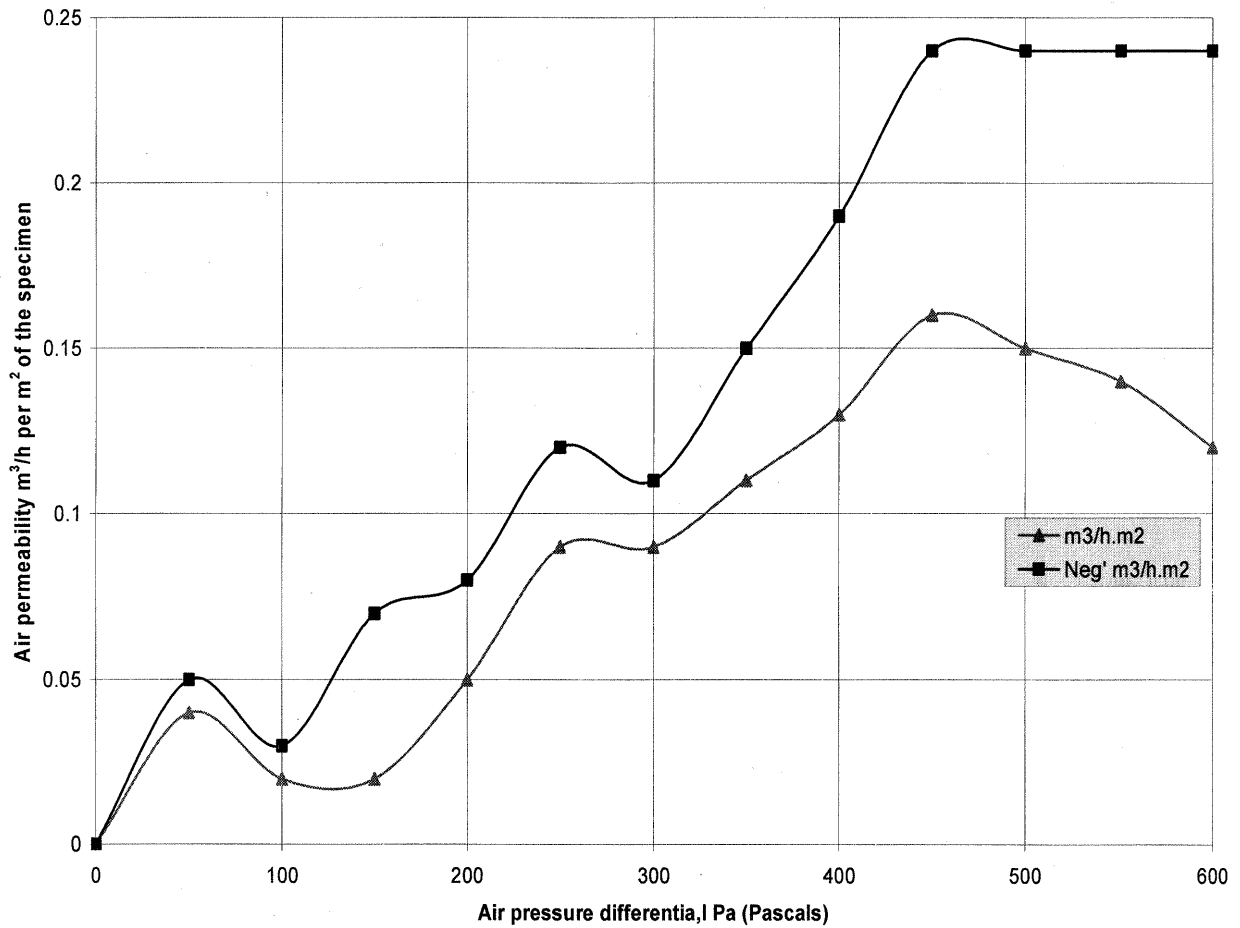
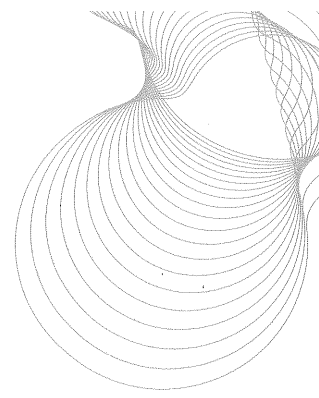
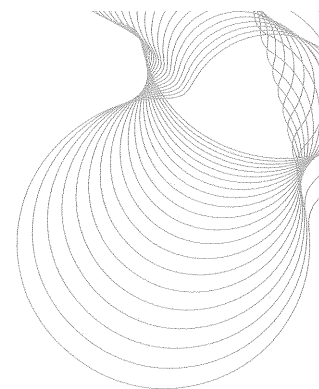

Figure A1. Air permeability under positive and negative air pressure; test results



Watertightness test

Pressure differential Pa	Duration Minutes	Water leaks
0	15	Nil
50	5	Nil
100	5	Nil
150	5	Nil
200	5	Nil
250	5	Nil
300	5	Nil
450	5	Nil
600	5	Nil

Test laboratory conditions: Air temperature 14.6°C. Test chamber air temperature 14.7°C
Air pressure 1022 mb. Relative humidity 56.7% at 14.6°C. Water temperature 17°C

Table A3. Watertightness test results

Resistance to wind load – Deflection test at ± 2000 Pa

Position deflection measured	Positive pressure P1 to +2000 Pa		Negative pressure P1 to - 2000 Pa	
	Deflection		Deflection	
	mm	defl./span	mm	defl./span
Mid height of intermediate mullion	5.28	1/444	5.69	1/412

Note: The deflection at the mid-point of a member is measured relative to its ends, e.g. with reference to Figure 1: Deflection at the mid-point = deflection at the mid-point – average of deflections at the two ends of the same member.

Table A4. Deflections measured on an intermediate mullion in the resistance to wind load test at ± 2000 Pa.

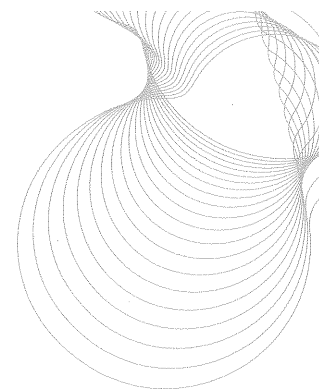

Resistance to wind load – Repeated pressure test including the second air permeability test

Repeated pressure	Damage or functional defects
50 cycles to P2 at ± 1000 Pa	None

Table A5. Damage or functional defects after repeated pressures to P2 at ± 1000 Pa

Second air permeability test under positive air pressures (part of resistance to wind load test)

Pressure differential Pa	Air flow through the specimen m^3/h	Comparison to the air permeability measured previously (see Table A1)
50	0.29	After the test pressures P1 and P2 were applied the amounts of air flowing through the test specimen were not significantly different to those measured previously
100	0.14	
150	0.16	
200	0.39	
250	0.62	
300	0.61	
450	1.07	
600	0.86	

Table A6. Second air permeability test results under positive air pressures

Second air permeability test under negative air pressures (part of resistance to wind load test)

Pressure differential Pa	Air flow through the specimen m^3/h	Comparison to the air permeability measured previously (see Table A2)
50	0.39	After the test pressures P1 and P2 were applied the amounts of air flowing through the test specimen were not significantly different to those measured previously
100	0.19	
150	0.45	
200	0.58	
250	0.84	
300	0.80	
450	1.75	
600	1.65	

Table A7. Second air permeability test results under negative air pressures

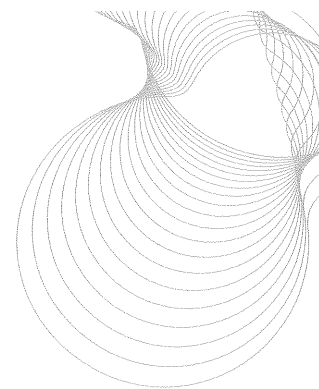

Resistance to wind load - Safety test

Safety test	Condition after test
One pressure pulse to pressure: P3 at – then + 3000 Pa	No parts became detached and the test specimen remained closed

Table A8. Condition of the glazed screen after the safety test to P3 at ± 3000 Pa

=====REPORT ENDS=====